

Multi-purpose containers MB, with locking system

MBD86421D BS1 | Data sheet

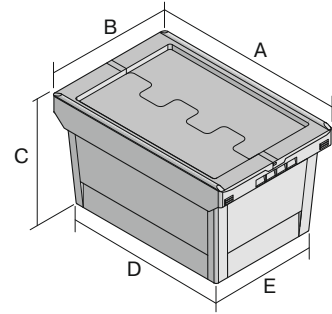

Pos. Dimensions, tolerances as specified in DIN 16901

Pos.	Dimensions, tolerances as specified in DIN 16901	
A	Outside length top	800 mm
B	Outside width top	600 mm
C	Height	453 mm
D	Base length outside	690 mm
E	Base width outside	508 mm

Product features	*Load capacity as specified in EN 13117
Proper weight	9.39 kg
*Stacking load	300 kg
*Load capacity	200 kg
Volume	147 Litres
ESD	No
Food safety	-
Material	PP
Stock item	-
Pcs/pack	1
Colour	dove blue
Ref. no.	6-20293

Other colours / special colours on request

Dimensions, tolerances as specified in DIN 16901	
Outside length top	800 mm
Outside width top	600 mm
Height	453 mm
Inside length top	682 mm
Inside width top	500 mm
Inside height	389 mm

Information & Service
www.bito.com

BITO
 STORAGE
 SYSTEMS

Multi-purpose containers MB, with locking system

MBD86421D BS1 | Accessories



Label covers
for multi-purpose containers MB
W 60 x H 80.4 mm
6-15244



Transport dolly
for multi-purpose containers sized
800 x 400 mm and 800 x 600 mm
L 720 x W 540 mm
6-19439